

Spring 2017

The effects of carboxylic acids in aluminum anodizing

Abby E. Koczera

University of New Hampshire, abbykoczera@gmail.com

Follow this and additional works at: <http://scholars.unh.edu/honors>

 Part of the [Metallurgy Commons](#), [Other Chemical Engineering Commons](#), [Other Materials Science and Engineering Commons](#), [Semiconductor and Optical Materials Commons](#), and the [Transport Phenomena Commons](#)

Recommended Citation

Koczera, Abby E., "The effects of carboxylic acids in aluminum anodizing" (2017). *Honors Theses and Capstones*. 330.
<http://scholars.unh.edu/honors/330>

This Senior Honors Thesis is brought to you for free and open access by the Student Scholarship at University of New Hampshire Scholars' Repository. It has been accepted for inclusion in Honors Theses and Capstones by an authorized administrator of University of New Hampshire Scholars' Repository. For more information, please contact nicole.hentz@unh.edu.

The effects of carboxylic acids in aluminum anodizing

Abstract

Hard-anodized alumina coatings were formed in sulfuric acid at low temperature and high current density in the presence of carboxylic acid additives. Citric acid, trimesic acid, mellitic acid and ethylenediaminetetraacetic acid (EDTA) were utilized in varying concentrations. The additives were chosen for their capacity to form complexes with tri-valent aluminum and hence impart chemical stability to the coatings. The coatings were sealed in boiling water, and corrosion resistance was observed in a high pH solution of potassium hydroxide. The coatings were examined using scanning electron microscopy (SEM) to assess coating thickness and pore dimensions. Thicker coatings were produced when the additive inhibited oxide coating dissolution, increasing corrosion resistance. Overall, carboxylic acid additives showed a positive impact on corrosion resistance when coupled with sealants. More research in this field could improve products used in cleaning and cooking environments to withstand conditions of high and low pH.

Keywords

Aluminum, carboxylic acid, corrosion, SEM, anodizing, sulfuric acid

Subject Categories

Metallurgy | Other Chemical Engineering | Other Materials Science and Engineering | Semiconductor and Optical Materials | Transport Phenomena

The effects of carboxylic acids in aluminum anodizing

Abby Koczera

May 2017 Honors Thesis

Department of Chemical Engineering

University of New Hampshire

Durham, New Hampshire 03824

Abstract

Hard-anodized alumina coatings were formed in sulfuric acid at low temperature and high current density in the presence of carboxylic acid additives. Citric acid, trimesic acid, mellitic acid and ethylenediaminetetraacetic acid (EDTA) were utilized in varying concentrations. The additives were chosen for their capacity to form complexes with tri-valent aluminum and hence impart chemical stability to the coatings. The coatings were sealed in boiling water, and corrosion resistance was observed in a high pH solution of potassium hydroxide. The coatings were examined using scanning electron microscopy (SEM) to assess coating thickness and pore dimensions. Thicker coatings were produced when the additive inhibited oxide coating dissolution, increasing corrosion resistance. Overall, carboxylic acid additives showed a positive impact on corrosion resistance when coupled with sealants. More research in this field could improve products used in cleaning and cooking environments to withstand conditions of high and low pH.

Introduction

The basic principles of chemical engineering are applied in this field of electrochemistry and include material and energy balances, thermodynamics, kinetics, and transport. Material and energy balances incorporate heats of reaction and rates of generation and consumption;

thermodynamics depends upon the concentrations and standard reduction potentials of bath components, pH, and possible reactions. Kinetics describes rates of reactions, and in this case for homogenous reactions in solution and heterogeneous reactions at the electrode surface, including faradaic reactions that entail the transfer of electrons and the amount of applied potential. In anodizing, reactants transport to the surface of the solid-liquid interface and products move away via diffusion and convection.¹

Aluminum anodizing is an electrolytic process that is used to coat the metal with a protective oxide layer. The oxide coating is formed on the aluminum by passing an electrical current through an acidic anodizing bath. The coating protects the aluminum beneath it, resisting corrosion and abrasion much more efficiently than raw aluminum.² The anodizing process includes the following reactions in which the aluminum metal is oxidized and further reacted with water to form alumina.

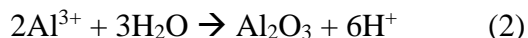
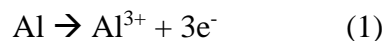

Alumina is a very hard material at all pH values. It is also corrosion resistant, but only at neutral pH. It is vulnerable to corrosion at high and low pH, such as household cleaning supplies and food product, respectively. Previous studies have been done to show how lithium additives help make alumina more resistant to corrosion. Although this research used one additive with the presence of lithium, the main objective was to address the benefits of adding organic carboxylate molecules to increase the stability and complexity of the anodized coating structure.

In anodizing, there are three main categories of additives: metal cations, complexing organic compounds, and surface active organic compounds. Although this research was focused primarily on the effect of complexing organic compounds, a

background on metal cations may be beneficial to understand the overall role of the specific additives used. Transition metal cations are generally added in simple salt form to mitigate the effects of by-products; if they exist in more than one valence state, they possess the potential to oxidize or reduce by-products in the bulk of the bath. Reduction potentials must be sufficiently positive or negative to drive oxidation or reduction, respectively. This idea may be used to compare the properties of the coatings based on the additives used. It is predicted that low concentrations of additives provide superior surface finishes, process stability, and uniform current distribution.¹

- (a) $O_2 + 4e^- + 4H^+ \rightarrow 2H_2O$
 (b) $H_2SO_4 + 2H^+ + 2e^- \rightarrow H_2SO_3 + H_2O$
 (c) $2H_2SO_4 + 2e^- \rightarrow S_2O_6^{2-} + 2H_2O$

Figure 1. Possible reactions and their standard reduction potentials: (a) 1.229V, (b) 0.172V, (c) -0.22V.¹

The formation of aluminum complexes with organic molecules is one of the most common additive mechanisms. In this case, the reaction of hard-ion carboxylates with trivalent aluminum cations will readily form complexes that result in insoluble metal soaps that are incorporated onto the surface of the anodic coating. Because the pKa value of carboxylic acids is higher than the pH of sulfuric acid baths, the molecules are expected to protonate and become neutral in solution, lacking the tendency to migrate toward the anode. Complexing additives form a thin film on the oxide surface to promote protection of the metal.¹ Additives that were used in this study include citric acid, trimesic acid, mellitic acid, and EDTA, the structures of which can be seen in Figure 2. Citric acid contains three carboxyl groups, connected by a five-carbon chain. Trimesic acid contains three carboxyl groups around every other carbon on a benzene ring; Mellitic acid contains six carboxyl groups branching off of a benzene ring; each

carboxylic acid is essentially connected by a four-carbon chain. EDTA is known as a chelating agent that will “trap” trivalent aluminum on contact. Corrosion tests in basic solutions were performed to measure the effects of additives with different carboxylic acid concentrations.

(a) Citric Acid

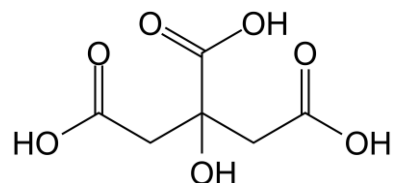

(b) Trimesic Acid

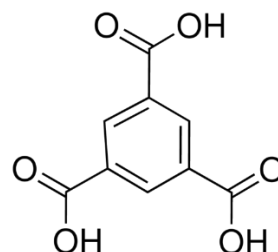

(c) Mellitic Acid

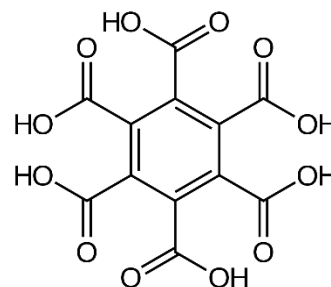

(d) EDTA

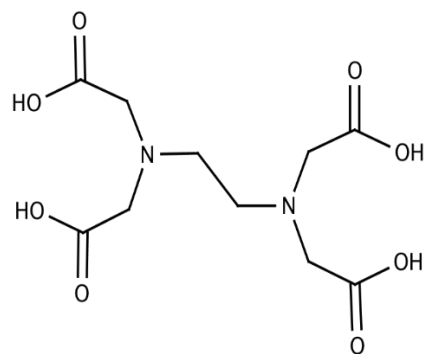

Figure 2. Chemical structures of each additive.³

Experimental

Aluminum Samples

Aluminum 6063 tubes, produced by K&S Precision Metals, were utilized for the experiments. The rods (0.25 inch diameter) were cut to a length of about six inches, ends crimped, and covered with shrink wrap to expose a controlled area of four square centimeters for anodizing. The rods were left exposed at the top half in order to make contact with the working electrode.

Chemical Solutions

The 10% volume anodizing bath solution was created with ACS grade J. T. Baker sulfuric acid (96.4%). 200mL of this solution was placed into a beaker and further in an ice bath, left to chill for an hour prior to anodizing. Different additives that were added to the solution include citric acid, trimesic acid, mellitic acid, and EDTA (Sigma-Aldrich, 99%).

Solutions of potassium hydroxide were created for cleaning the rods (2M) and to perform corrosion tests (0.5M) using ACS grade pellets produced by Fisher Scientific (88.4%). Boiling water was used for coating treatment prior to corrosion tests.

Anodizing

The general procedure for anodizing began by cooling sulfuric acid solution in an ice bath for one hour (200mL, 10% volume). During that time, an aluminum sample was cleaned in potassium hydroxide (10mL, 2M) until the protective manufacturer coating was stripped off and clean aluminum metal was visible over the entire working area. Once removed from the basic wash, the sample was thoroughly rinsed with deionized water and placed in the electrolyte cell as the working electrode.

The working electrode and counter electrode (titanium rod, cleaned in potassium

hydroxide) were placed in the chilled sulfuric acid solution, held by clamps and suspended above the bottom of the beaker. Different additives were added by mass (10mg, 100mg) to the solution at room temperature and the process repeated.

Wires from the galvanostat connected the circuit, as seen in Figure 3. Once the equipment was turned on, the cell was left untouched. PowerSuite software was utilized to measure potential versus time during chronopotentiometric hard anodizing, with an initial current step of -140.0 mA for 0.100 seconds. Each experiment was run for 40 minutes with a current density of 35 mA/dm², and potential was measured with a voltmeter every two minutes. Once complete, the samples were rinsed with deionized water, dried, and placed in a labeled envelop for treatment and testing. The anodizing bath was saved and utilized about three to four times before discarding.

Treatments

The collection of samples anodized with various additive concentrations were treated to test the effects on corrosion resistance. The rods were treated in boiling water for fifteen minutes.

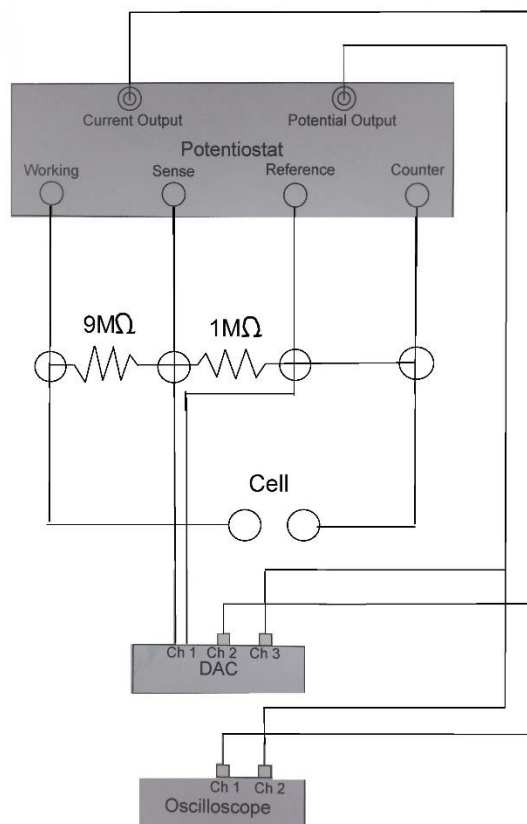

Figure 3. A schematic of the cell.

Corrosion Tests

Corrosion tests were completed in caustic solution. For each test, the initial masses of three anodized samples were recorded using a standard scale. The samples were then placed in approximately 150mL of KOH (0.5M). Times were recorded at which noticeable behaviors were seen, including the appearance of bubbles and their progression, the appearance of streaks on the metal, the presence of clean metal and how long it took for the entire anodized area to be corroded, etcetera. The way the coating was stripped from the rod was observed as well, sometimes falling off in multiple millimeter-long delicate flakes, or polluting the solution in the shape of particles smaller than a grain of sand. After a period of 60 minutes, the samples were wiped of residual smut. The corroded samples were rinsed with water,

dried, and weighed; total mass lost was calculated.

Scanning Electron Microscope (SEM)

A selection of samples were viewed under the SEM to observe structural variations in the anodized coatings based on the presence of different additives. The rods were cut radially to view the coating thickness and pore behavior. Pictures were taken at various magnifications, with a maximum working distance of 9.71 mm, a beam intensity of about 5, and an applied voltage of 6.0kV. Coating thickness and pore dimensions were measured using Tescan analysis software. Image quality, judged by the appearance of streaks or uneven shading, is a result of the microscope resolution and the ability of electrons to reach the detector.

Results and Discussion

The following figures are a compilation of the data obtained from numerous trials of anodizing. Potential is the driving force of the reaction. The steeper slopes indicate higher potential increase with time and thus a thicker coating, whereas the more gradual slopes indicate a thinner coating in the presence of an additive with oxide coating dissolution properties.

Coating thickness can be related to the behavior quantized in the graph in Figure 5. Higher potential increases with time indicates the growth of a thicker coating. The addition of additives produced a thinner coating, with the exception of 10mg citric acid, which had a higher potential increase than the control sample. It is anticipated that thicker coatings have a higher resistance to corrosion.

Trimesic acid samples differed little from the control sample. Although very similar, the higher additive concentration had a slightly lower potential increase than the lower additive concentration.

Mellitic acid showed the same potential behavior as the control sample. It was slightly lower than trimesic acid overall, so

this implies that mellitic acid will have thinner coatings of the pair. Although there is virtually no distinction between the concentrations of mellitic acid, the higher sits below the lower, similar to the trend with trimesic acid.

Of the entire spread, EDTA potential increase sits the greatest magnitude below the control sample. EDTA may have allowed or enhanced the dissolutive properties of the electrolyte, forcing a thinner oxide layer to result. After 30 minutes the concentrations diverge, contrary to the behaviors of the rest of the collection.

The coating is created from the surface of the metal. As the coating gets thicker, the current has to pass through the growing layer to reach the clean metal surface. This mechanism explains that corrosion resistance improves as coating thickness increases. As the coating grows from the bottom up, it may simultaneously be dissolved at the surface. The aggressiveness of the electrolyte is dependent on the properties of the additives in the acid. Thicker coatings are produced when the additive inhibits oxide coating dissolution. Table 1 organizes the thickness

measurements of each coating; contrasting trends may be due to experimental error.

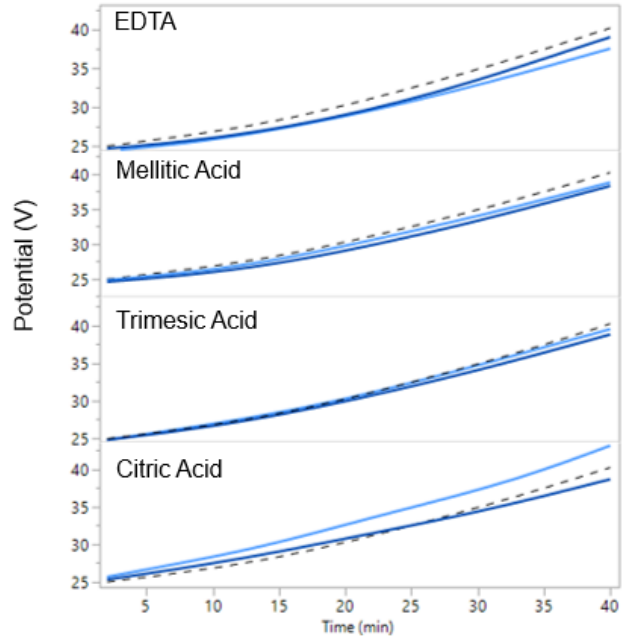

Figure 5. Potential over time for each additive. Dashed black line is the control sample (no additives), light blue is 10mg and dark blue is 100mg.

Table 1. SEM measurements and mass lost during corrosion testing for each sample.

Additive	Quantity (mg)	Coating Thickness (μm)	Pore Diameter (nm)	Pore Spacing (nm)	Mass Lost (g)
None	-	46	23	68	0.06
Citric Acid	10	48	29	78	0.07
Citric Acid	50	41	21	73	0.02
Trimesic Acid	10	55	20	61	0.02
Trimesic Acid	50	46	23	69	0.02
Mellitic Acid	10	49	24	83	0.06
Mellitic Acid	50	50	25	80	0.06
EDTA	10	45	30	87	0.06
EDTA	50	42	31	87	0.06

The coating thickness for the control sample was measured to be 46 microns. Overall, citric acid, EDTA, and trimesic acid followed the same trend where 10mg yielded a thicker coating than the 50mg. The magnitude of the difference varies, with trimesic acid having the biggest change and EDTA the smallest. This supports the hypothesis that lower

concentrations of additives result in thicker coatings. Mellitic acid has a contrasting trend, with the 50mg sample having a bigger thickness than the 10mg sample (Fig. 6). It is proposed that additional additive contributes to coating dissolution, however this may not be the effects of mellitic acid.

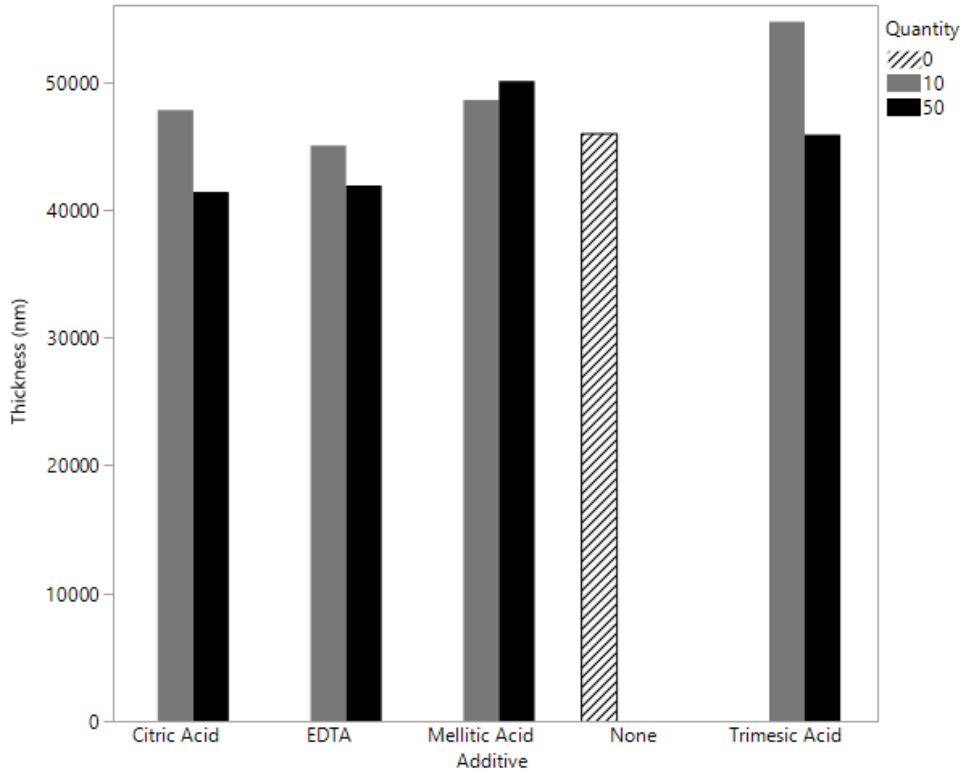

Figure 6. Average coating thickness measurements for each sample.

Figure 7 illustrates the relationship between pore diameter and pore spacing. Diameter is on the ordinate (0-35nm), and pore spacing is arranged by a color slide (60-88nm). It is expected that large pore diameters also have large spacing between them. Small pore diameters and large spacing are intriguing because that would imply a denser coating. Tall, purple bars indicate a sample with large

pore diameter and consequently large spacing. Both EDTA samples characterized this behavior, followed by mellitic acid with the next largest characteristics. Overall, most samples had very similar characteristics to the control sample. EDTA and 10mg citric acid had the biggest deviations, resulting in wide pores and spacing.

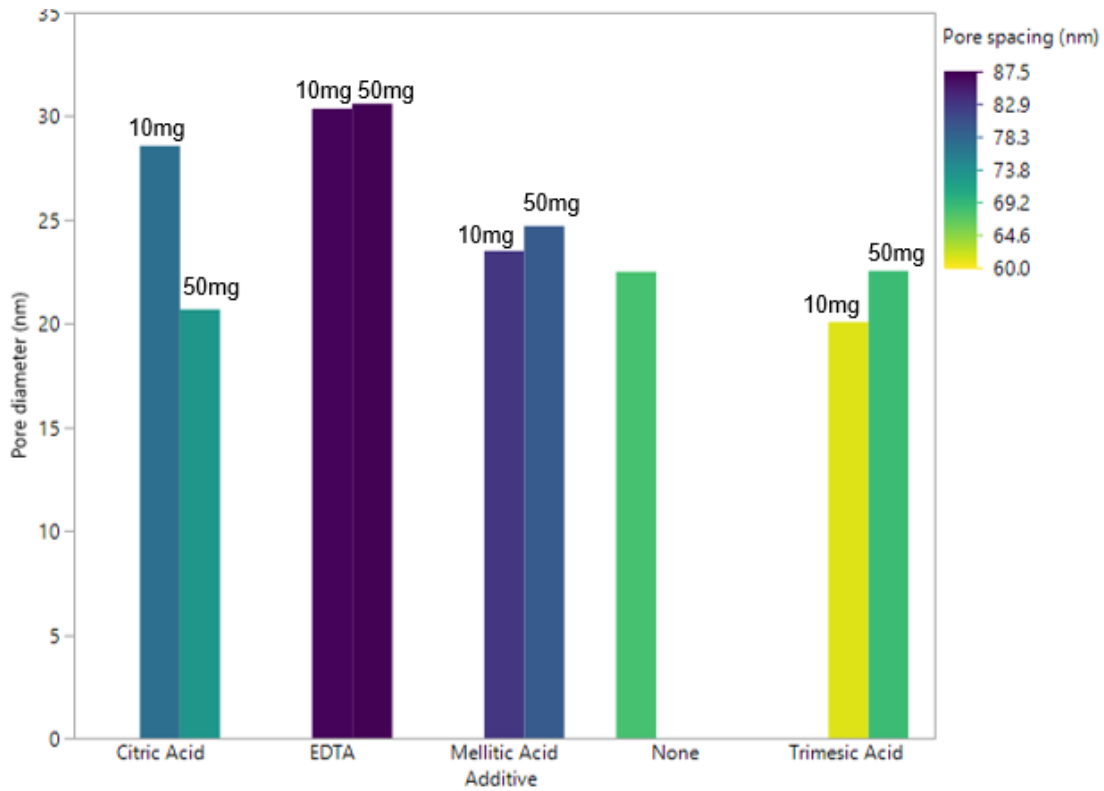
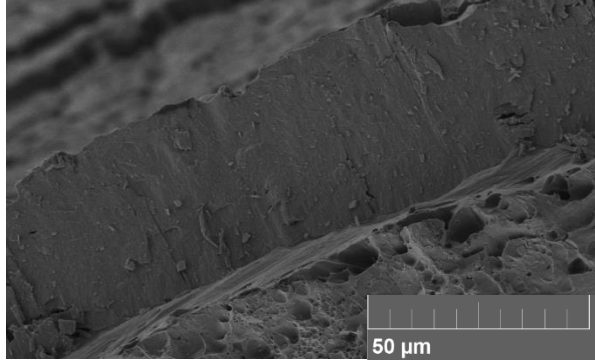
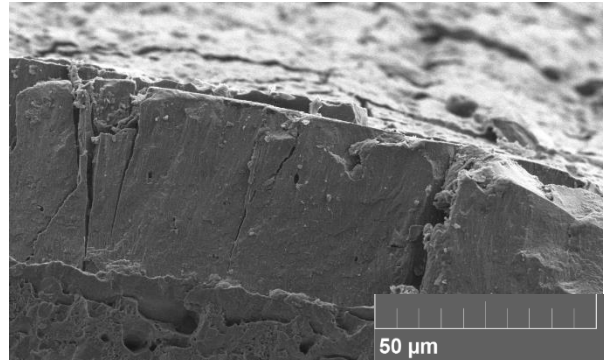

Figure 7. Pore diameter (ordinate) and pore spacing (color scale) results for each sample using SEM measurements.



10mg EDTA



10mg Mellitic Acid

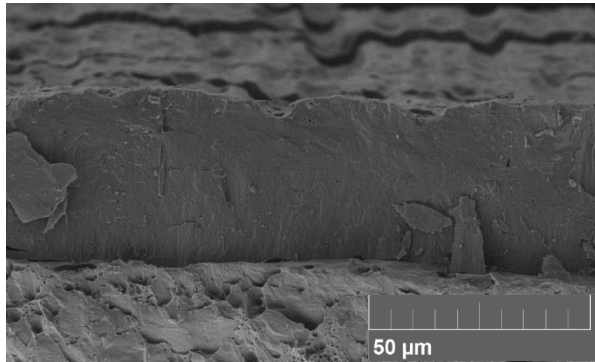

50mg EDTA

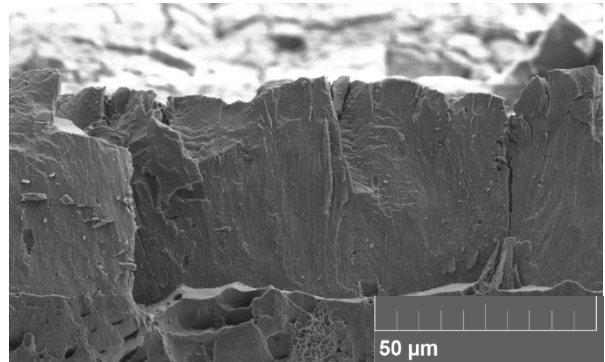

No additives

Figure 8. Cross-sectional SEM images of four anodized samples. Magnification is 2.77kx.

Cross-sectional images were taken using a SEM. Coating thickness was measured at a working distance of 5.11mm and a magnification of 2.77 kx. Pore diameter and

spacing were measured at a working distance of 8.13 mm and a magnification of 369 kx. Figures 8-9 show a selection of images taken of the samples.

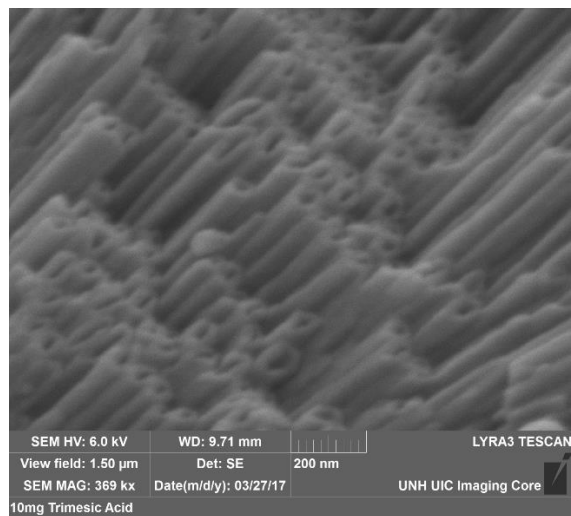
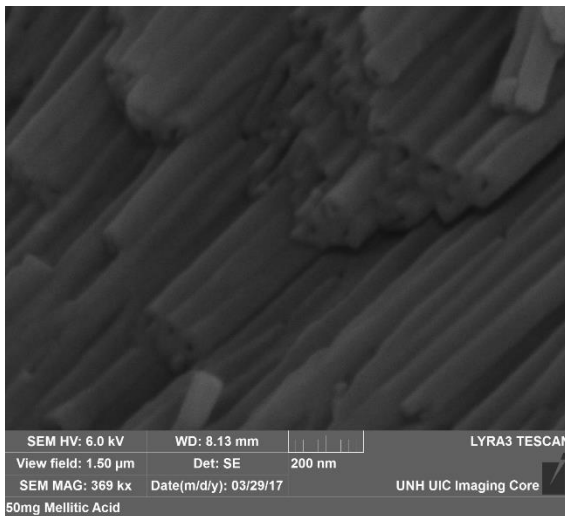

Figure 9. SEM pore images of 50mg mellitic acid (left) and 10mg trimesic acid (right).

Corrosion Results

After anodizing, each sample was sealed for 15 minutes in boiling water and then weighed. In groups of three, the samples were placed in 300ml of 0.5M potassium hydroxide. Pictures were taken periodically throughout the duration of the corrosion test. The samples were observed over 60 minutes. At full on corrosive attack, there were rapid bubbles coming from the surfaces of the coatings (Fig. 10). Aggressive bubbling set on at 10 minutes for EDTA, 15 minutes for citric acid, 20 minutes for trimesic acid, and 20 minutes for mellitic acid. It is possible that trimesic acid and mellitic acid had the highest resistance to corrosion. It was hard to distinguish resistivity between the samples of different concentrations. After 60 minutes, residual smut was wiped off and the sample was weighed to obtain mass lost.

The mass lost after corrosion testing should be proportional to the thickness of the coating. Residual mass after the 60 minute testing period indicates a strong coating. Of the set, trimesic acid (50mg) and EDTA (10mg) appeared to have some coating remaining after corrosion (Fig. 11). The rest of the samples seem to have a clean finish from a completely removed coating. Figure 12 depicts the relationship between coating thickness and mass difference. Trimesic acid had the thickest coatings and lost the least amount of mass. Coupled by its physical appearance (Fig. 11), it appears that trimesic acid may have had the best resistance to corrosion. EDTA and mellitic acid samples had the same mass differential as the control sample. Citric acid at 10mg had the highest loss of mass. Combined with a relatively thick coating, it is likely that this concentration of citric acid was susceptible to corrosion. Citric acid at 50mg had the lowest loss of mass and the lowest thickness. Citric acid samples appear very clean post

corrosion (Fig. 11). It is evident that citric acid added little corrosion resistance to the coating.

The mass lost after corrosion testing should be proportional to the rate of corrosion. Additives make the solution more aggressive and may reduce the coating thickness as a result. But, they do appear to impart corrosion resistance since there was residual mass after the 60 minute testing period. The additives probably form a protective, though thinner, coating. Of the set, trimesic acid (50mg) and EDTA (10mg) appeared to have some coating remaining after corrosion (Fig. 11). The rest of the samples seem to have a clean finish from a completely removed coating. Figure 12 depicts the relationship between coating thickness and mass difference. Trimesic acid had the thickest coatings and lost the least amount of mass. Coupled by its physical appearance (Fig. 11), it appears that trimesic acid may have had the best resistance to corrosion. EDTA and mellitic acid samples had the same mass differential as the control sample. Citric acid at 10mg had the highest loss of mass. Combined with a relatively thick coating, it is likely that this concentration of citric acid was susceptible to corrosion. Citric acid at 50mg had the lowest loss of mass and the lowest thickness. Citric acid samples appear very clean post corrosion (Fig. 11). It is evident that citric acid added little corrosion resistance to the coating. The results suggest an ideal concentration range for each additive that is high enough to form a proper coating but not excessive to dissolve the coating during anodizing.

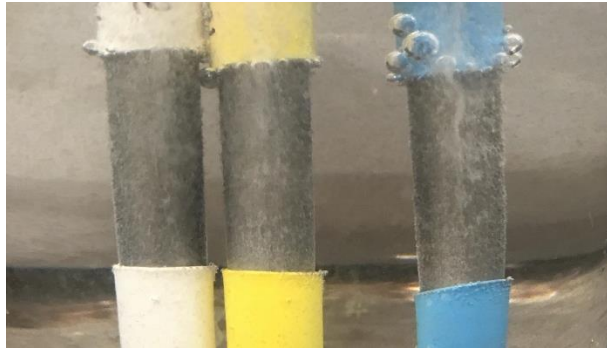

Citric Acid: 10 minutes

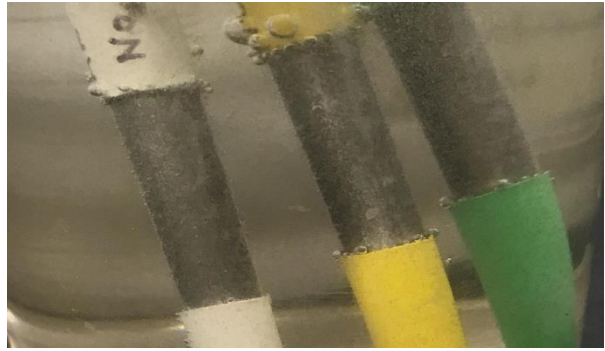

Mellitic Acid: 10 minutes

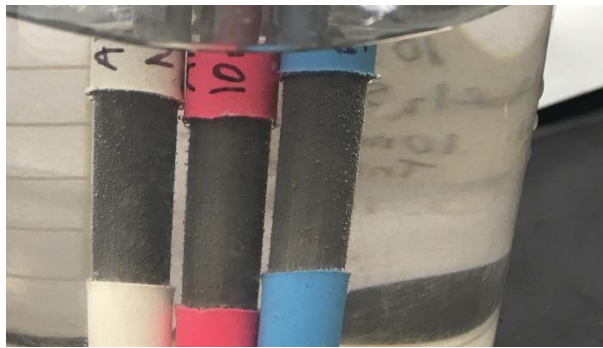

Trimesic Acid: 5 minutes

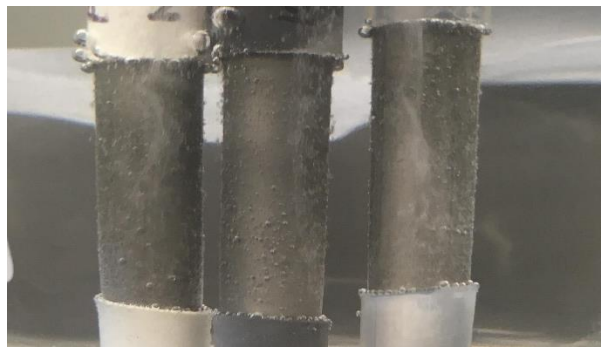

EDTA: 10 minutes

Figure 10. Samples undergoing corrosion testing in 0.5M KOH. From left to right in each picture ranks additive concentration (0, 10, 50mg).



Figure 11. Samples after corrosion testing. The average mass lost was 0.05g, ranging from 0.02 to 0.07g. From left to right: no additives, 10mg mellitic acid, 50mg mellitic acid, 10mg trimesic acid, 50mg trimesic acid, 10mg citric acid, 50mg citric acid, 10mg EDTA, 50mg EDTA.

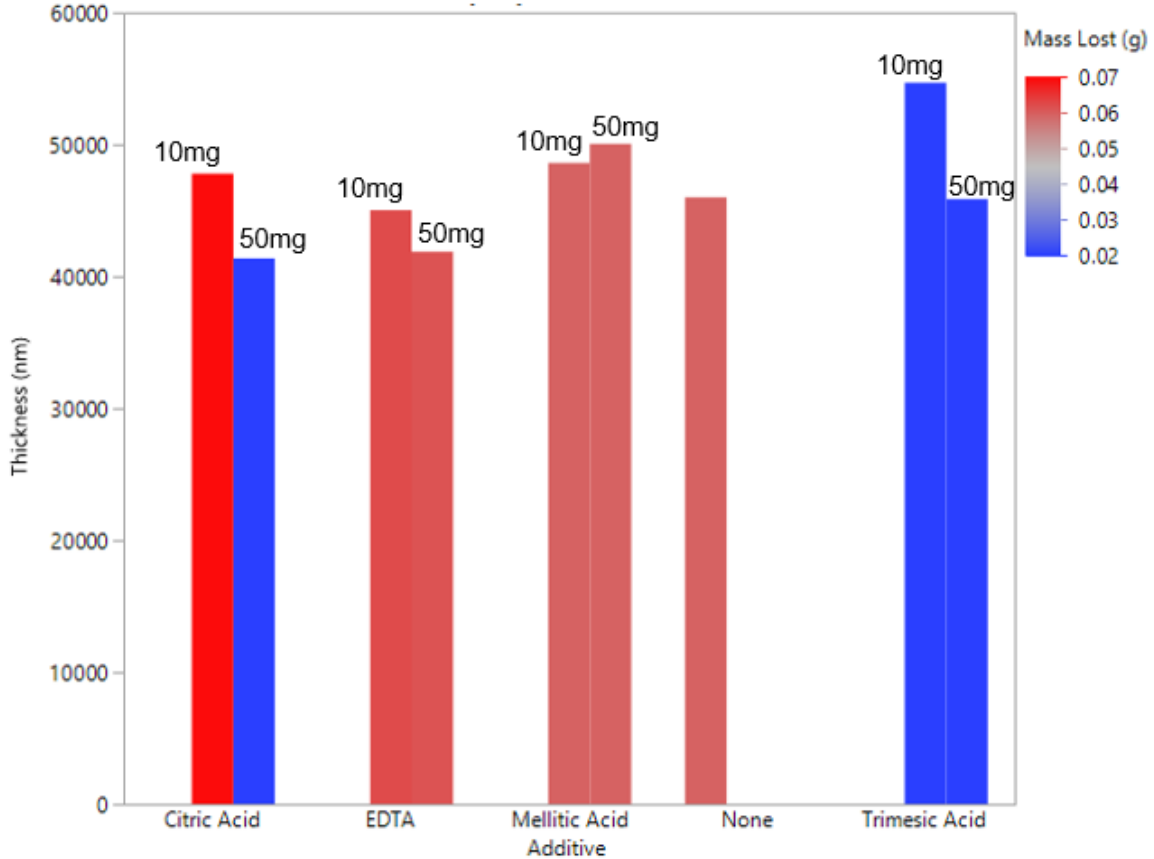

Figure 12. Comparison between mass lost and coating thickness for each sample. Tall, blue bars indicate resistance to corrosion.

Conclusion

This research explored the effects of carboxylic acids on alumina coatings. The three major steps of the project included anodizing, sealing treatments, and corrosion tests; a selection of the anodized samples were further analyzed using scanning electron microscopy. During anodizing, carboxylic acid additives including citric acid, trimesic acid, mellitic acid, and ethylenediaminetetraacetic acid (EDTA) were added to the baths in various concentrations and cell potential was measured over time. It was expected that a high potential growth rate correlates to thick coatings, and that lower

additive concentrations would improve corrosion resistance.

The results showed that lower concentrations of additives inhibit coating dissolution, and additional additive contributes to the dissolution. The results from pore diameter and pore spacing showed little variation for trimesic, mellitic, and citric acid. 10mg citric acid and EDTA had the largest diameters and consequently, the biggest spacing. Corrosion testing and mass differential indicated trimesic acid as the most resistant sample. The results suggest an ideal concentration range for each additive that is high enough to form a proper coating but not

excessive to dissolve the coating during anodizing.

Ways to improve these conclusions would be to lengthen anodizing time and observe later behavior among the combinations, as well as repeat measurements under SEM of samples under the same conditions to rectify areas of experimental error. Overall, the presence of carboxylic acids in alumina positively impacted its corrosion resistance when coupled with sealing treatments, but there was not a consistent pattern of trends that could lead to a specific conclusion without further experimentation, data collection and evaluation.

References

- (1) Barkey, D. *A Chemical Process Engineering View of Additives in Aluminum Anodizing*, University of New Hampshire Department of Chemical Engineering, (2012).
- (2) Global Metal Finishing, About Anodizing. <http://www.globalmetalfinishing.com/anodizing-faqs>. (accessed Dec 28, 2015).
- (3) PubChem, U.S. National Library of Medicine. Compounds: Glutaric Acid, Mellitic Acid, Lithium Citrate. http://pubchem.ncbi.nlm.nih.gov/compound/glutaric_acid. (accessed Dec 28, 2015).
- (4) Spathis, P. *Effect of bicarboxylic acids on the protection of anodic coated Al-alloys against SCC*, Proceedings of the Symposium on Advances in Corrosion Protection by Organic Coatings II, **95**, 309-321, (1995).