

9-1-1995

Large-area submillimeter resolution CdZnTe strip detector for astronomy

James M. Ryan

University of New Hampshire, James.Ryan@unh.edu

John R. Macri

University of New Hampshire - Main Campus, John.Macri@unh.edu

Mark L. McConnell

University of New Hampshire - Main Campus, mark.mcconnell@unh.edu

Brian K. Dann

University of New Hampshire - Main Campus

M.L. Cherry

Louisiana State University - Baton Rouge

See next page for additional authors

Follow this and additional works at: <https://scholars.unh.edu/ssc>

 Part of the [Astrophysics and Astronomy Commons](#)

Recommended Citation

James M. Ryan ; John R. Macri ; Mark L. McConnell ; Brian K. Dann ; Michael L. Cherry ; T. Gregory Guzik ; F. P. Doty ; Boris A. Apotovsky and Jack F. Butler "Large-area submillimeter resolution CdZnTe strip detector for astronomy", Proc. SPIE 2518, EUV, X-Ray, and Gamma-Ray Instrumentation for Astronomy VI, 292 (September 1, 1995); doi:10.1117/12.218403; <http://dx.doi.org/10.1117/12.218403>

This Conference Proceeding is brought to you for free and open access by the Institute for the Study of Earth, Oceans, and Space (EOS) at University of New Hampshire Scholars' Repository. It has been accepted for inclusion in Space Science Center by an authorized administrator of University of New Hampshire Scholars' Repository. For more information, please contact nicole.hentz@unh.edu.

Authors

James M. Ryan, John R. Macri, Mark L. McConnell, Brian K. Dann, M L. Cherry, T G. Guzik, F P. Doty, Boris A. Apotovsky, and J F. Butler

Large area sub-millimeter resolution CdZnTe strip detector for astronomy*

J.M. Ryan, J.R. Macri, M.L. McConnell, B.K. Dann

Space Science Center,
University of New Hampshire
Durham, NH

M.L. Cherry, T.G. Guzik

Department of Physics and Astronomy,
Louisiana State University
Baton Rouge, LA

F.P. Doty, B.A. Apotovsky, J.F. Butler
DIGIRAD, San Diego, CA

ABSTRACT

We report the first performance measurements of a sub-millimeter CdZnTe strip detector developed as a prototype for space-borne astronomical instruments. Strip detector arrays can be used to provide two-dimensional position resolution with fewer electronic channels than pixellated arrays. Arrays of this type and other candidate technologies are under investigation for the position-sensitive backplane detector for a coded-aperture telescope operating in the range of 30-300 keV. The prototype is a 1.4 mm thick, 64×64 stripe CdZnTe array of 0.375 mm pitch in both dimensions, approximately one square inch of sensitive area. Pulse height spectra in both single and orthogonal stripe coincidence mode were recorded at several energies. The results are compared to slab- and pixel-geometry detector spectra. The room-temperature energy resolution is < 10 keV (FWHM) for 122 keV photons with a peak-to-valley ratio $> 5:1$. The response to photons with energies up to 662 keV appears to be considerably improved relative to that of previously reported slab and pixel detectors. We also show that strip detectors can yield spatial and energy resolutions similar to those of pixellated arrays with the same dimensions. Electrostatic effects on the pulse heights, read-out circuit complexity, and issues related to design of space borne instruments are also discussed.

Keywords: CdZnTe, strip detector, x-ray astronomy, gamma-ray astronomy, imaging

1. INTRODUCTION

The next step in the development of hard x-ray telescopes for astronomical imaging will require improvements both in angular resolution and in energy resolution.^{1,2} A common approach to imaging at these energies involves coded aperture imaging techniques, where the angular resolution depends directly on the spatial resolution of the detector plane.³ Imaging detectors constructed of CdZnTe⁴ represent a strong candidate technology for achieving both improved angular and energy resolution. We have developed a concept for a new instrument, MARGIE (Minute-of-Arc Resolution Gamma Imaging Experiment), that will be capable of imaging with good energy and arc-minute angular resolution both steady-state and transient sources of cosmic gamma rays.¹ Initially, this is intended to be flown as a balloon payload. Eventually, however, this design could be employed on an orbiting platform. Motivated by the MARGIE concept and by recent

* This work is supported by a 1993 Supporting Research and Technology grant under NASA's High Energy Astrophysics Gamma Ray Astronomy Research and Analysis program.

demonstrations of CdZnTe imaging detectors,^{5,6,7} we have been pursuing the development of CdZnTe arrays for astronomical imaging.

2. PROTOTYPE STRIP DETECTOR

Figure 1 is a photograph of the prototype strip detector manufactured by DIGIRAD of San Diego, CA . It consists of a monolithic Cd_{0.9}Zn_{0.1}Te substrate measuring 26 × 26 mm by 1.4 mm thick with 64 gold stripe contacts and 2 guard stripes on each surface. The stripe pitch and thus pixel definition is 0.375 mm in both dimensions, with an effective imaging area of 576 mm². The CdZnTe array is mounted in a PCB carrier with contacts to all stripes in a standard pin grid array pattern to facilitate safe handling and testing.

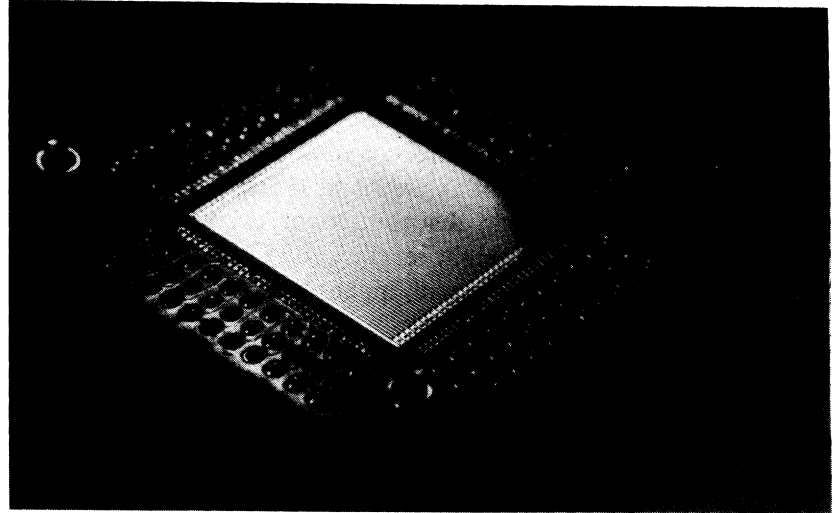

Figure 1. Photograph of prototype CdZnTe array

3. TEST SETUP

Figure 2 illustrates the laboratory setup for the prototype strip detector tests. Conventional laboratory electronics (charge sensitive preamplifiers, NIM and CAMAC amplifiers and ADCs) read out the signals and record the data. The small number of available signal processing channels limits the detector area that can be evaluated in any given test but allows flexibility in testing. All stripes on each detector surface are biased to assure a uniform electric field in the CdZnTe. Three neighboring contact stripes on each surface (X1, X2, X3 and Y1, Y2, Y3) are selected and ac coupled to signal processing channels. Signals from the middle stripe of the three stripes on each surface (X2 and Y2, referred to as trigger stripes) are directed to a lower level discriminator and coincidence logic that in turn provides a strobe to the ADC. All untested stripes are ac coupled to ground. Six pulse heights are recorded for each registered event.

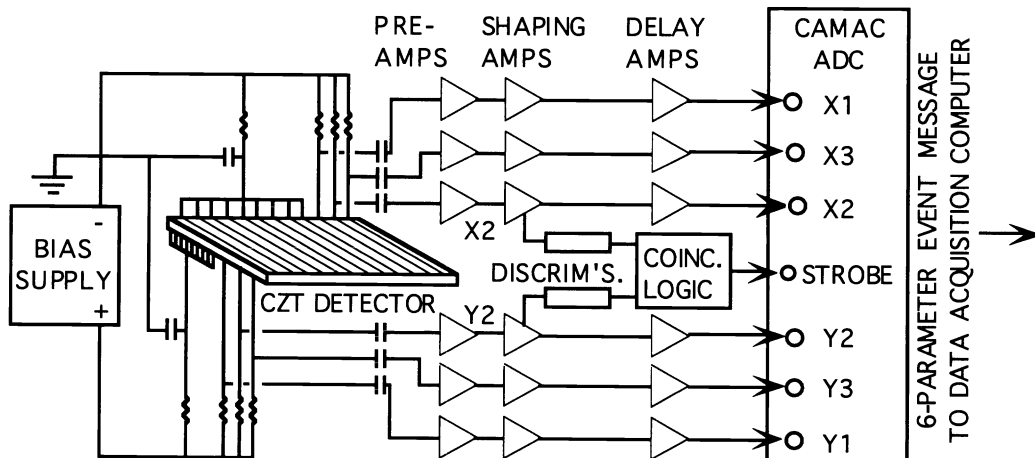

Figure 2. Test setup.

For these tests the detector was uniformly illuminated from the negatively-biased side. All measurements were performed at room temperature.

4. PERFORMANCE

4.1 Single stripe energy response (no X-Y coincidence)

Figure 3a illustrates the response of a single positively-biased stripe of our prototype array to 122 keV photons. The signal is self-gated. Photon interactions along the full 26 mm length of the stripe were recorded. This response has characteristics similar to those shown in Figure 3b. Figure 3b is the corresponding response of a more conventional single-contact CdZnTe slab detector fabricated with similar material and having the similar area and thickness (3mm × 3 mm × 1.5 mm thick) as one stripe from our prototype array. The broad distribution of events with pulse heights below the photopeak is a familiar characteristic of the pulse height response of CdZnTe spectrometers. It is due to poor collection of the holes and is often partially corrected with higher bias potentials.

Figure 3. 122 keV response (stripe and slab)

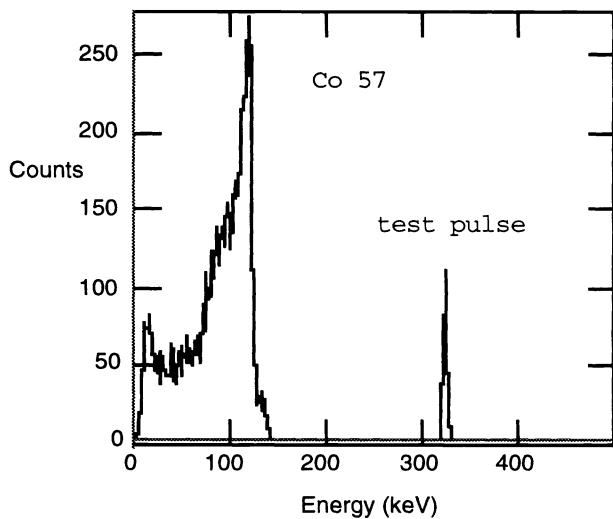

Figure 3a. Prototype strip detector. Single stripe, ungated. 24 mm length, 0.375 mm width, 1.4 mm thick. 300 volt bias.

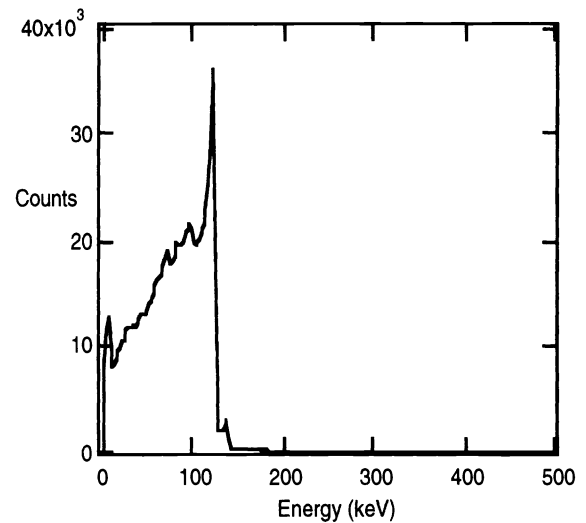

Figure 3b. Conventional single element CdZnTe slab detector. 3 mm × 3 mm × 1.5 mm thick. 600 volt bias.

4.2 Single "pixel" energy response (with X-Y coincidence)

The energy response of the center stripe (Y2 in our setup) is considerably improved when events are further localized along its length by requiring a trigger coincidence with an orthogonal, negatively biased, contact stripe (X2) on the detector's opposite surface. We call the overlapping area of the two orthogonal stripes a "pixel." In Figure 4 we compare the response at 122 keV of this 0.375 × 0.375 mm "pixel" defined by the X2-Y2 stripe coincidence (Figure 4a) to that of a single 0.5 × 0.5 mm test pixel from a 1.2 mm thick pixellated array substrate (Figure 4b).⁸

Figure 4. 122 keV response (“pixel” vs. pixel)

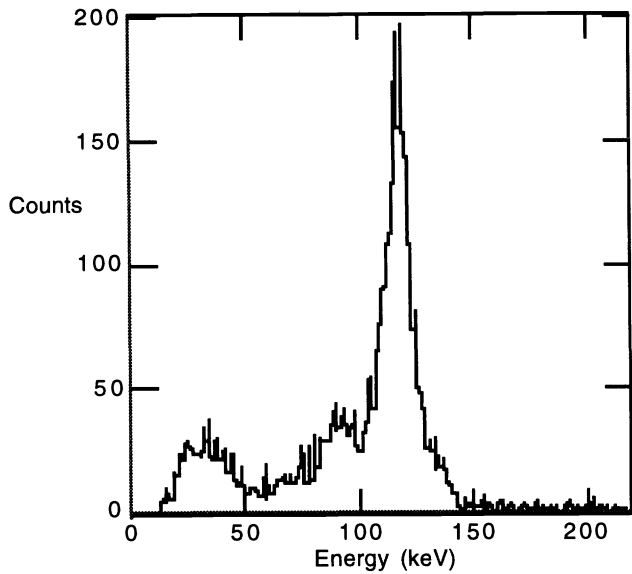

Figure 4a. Prototype strip detector.
Single “pixel” defined by X-Y coinc.
FWHM: 9.8 keV at 122 keV
(test pulse 5.5 keV, not shown).

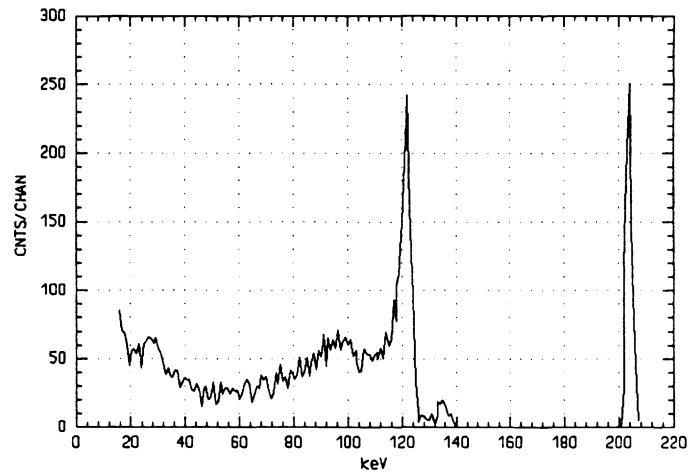

Figure 4b. Pixellated CdZnTe array.
Single 0.5×0.5 mm test pixel
FWHM: 3.8 keV at 122 keV
(test pulse 2.7 keV).

The spectral shapes and peak to valley ratios of the two detectors ($\sim 5:1$) are comparable. Neither spectrum exhibits the broad tail below the photopeak observed without gating or from larger detector elements (cf. Figure 3). However, the strip detector “pixel” energy resolution at 122 keV is not as good as that of the 0.5 mm square pixel. This reflects the fact that the stripe capacitance is more than 30 times that of the pixel and that the strip detector test setup involves numerous connections between the stripe and the preamp.

The geometry and coincidence requirement define a small pixel region for charge collection for each event. The “small pixel effect” results in energy spectra with significantly improved photopeak definition and energy resolution.⁹ For pixel geometries careful segmenting of the contacts reduces the effects of hole trapping on the output. Our results suggest that similar arguments can be applied to strip detectors.

Figures 5a-d further illustrate the single “pixel” response of our prototype array over a range of photon energies (30 keV to 662 keV). The energy scale is given in channel units since amplifier gains were adjusted to extend the energy range.

Figure 5. Strip detector single “pixel” response

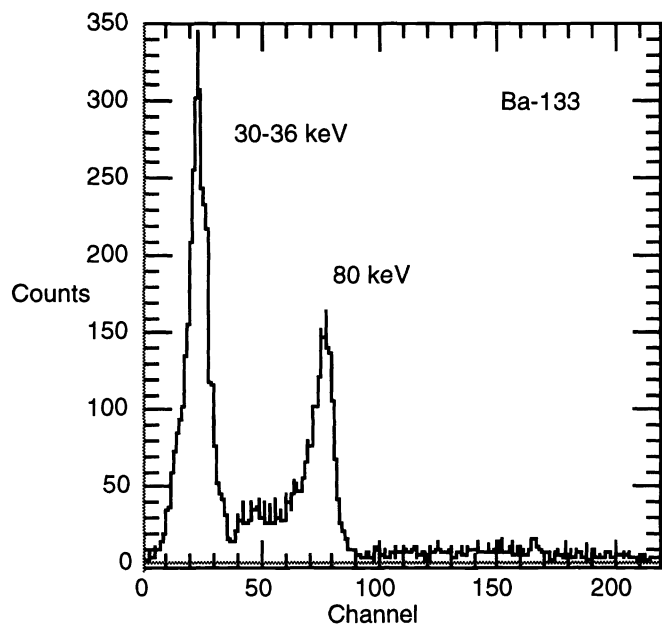

Figure 5a. ^{133}Ba response.
FWHM 10.6 keV @ 80 keV

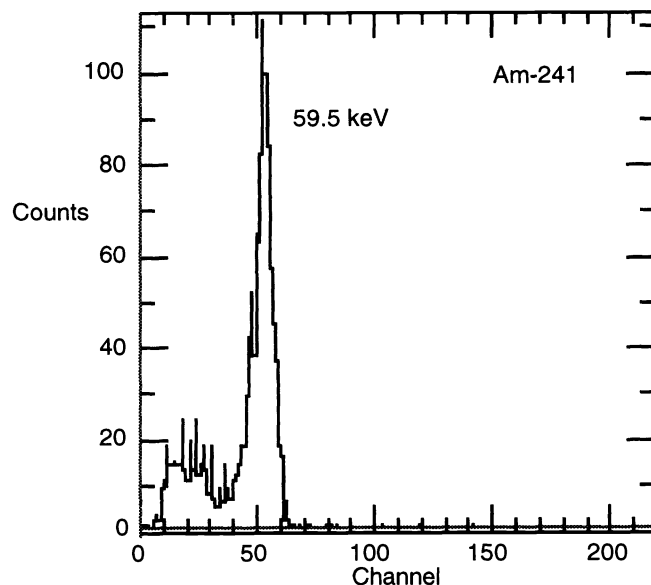

Figure 5b. ^{241}Am response
FWHM 7.9 keV @ 59.5 keV

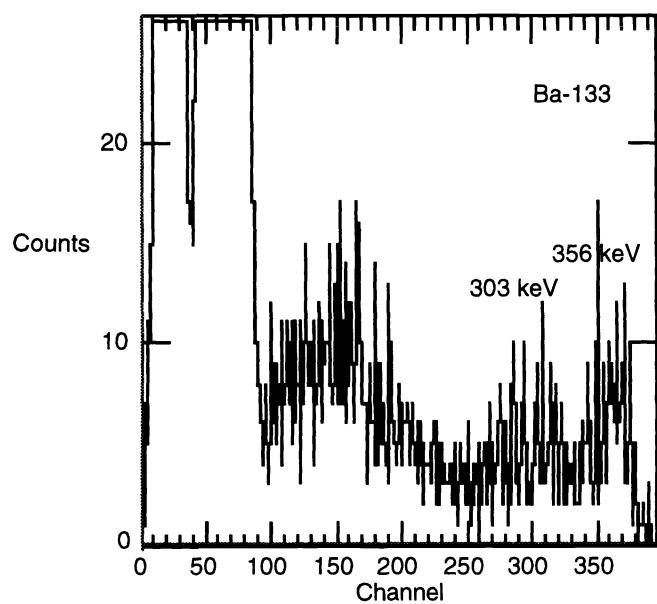

Figure 5c. ^{133}Ba response. Same data
as in Figure 5a. Expanded vertical scale
illustrates higher energy response.
FWHM 36 keV @ 356 keV

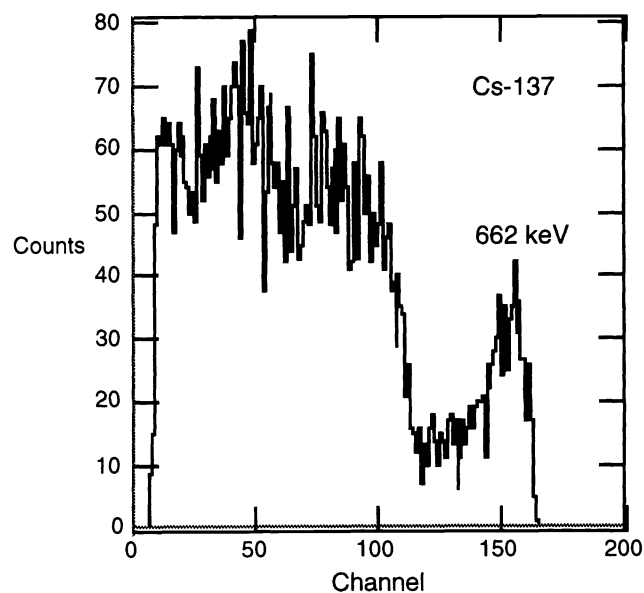

Figure 5d. ^{137}Cs response.
FWHM 86 keV @ 662 keV

Note that the higher energy photopeaks from the ^{133}Ba source are resolved despite poor statistics. The FWHM of the test pulse (not shown) is 6.9 keV.

Figure 6 is the 662 keV response of the 0.5×0.5 mm test pixel from the pixellated array substrate described above.⁸ Unlike at 122 keV (cf. Figures 4a-b), the responses of the square pixel and the X2-Y2 coincident “pixel” of the strip detector (cf. Figure 5d) differ sharply. The photopeak fraction in the strip detector coincidence spectrum is an order of magnitude higher than that for the pixel, and the peak-to-Compton count ratio is approximately equal to the ratio of photoelectric and Compton cross sections for the material.

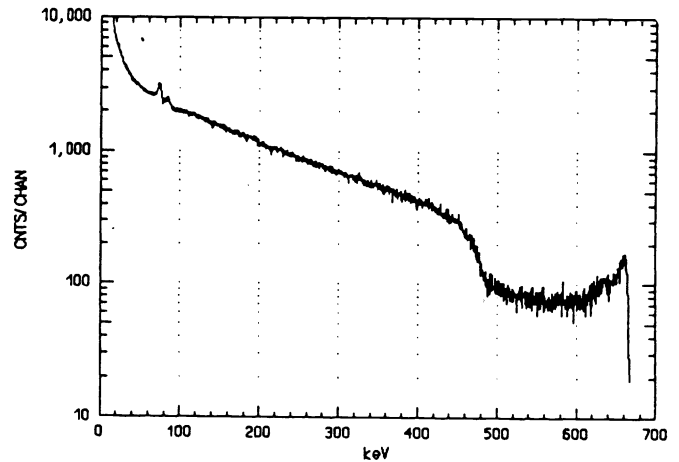

Figure 6. 0.5 mm square test pixel from pixellated array. Response at 662 keV.

4.3 Signal distribution among adjacent stripes

Further data analysis reveals the potential for both improved position determination and energy response. As above, an uncollimated ^{57}Co source is used to uniformly illuminate the detector from the negatively biased side. An event is registered when coincident triggers from stripes X2 and Y2 occur. Figure 7a is an event-by-event scatter plot of the pulse height from stripe Y1 vs. the corresponding pulse height measured from Y3, the neighboring stripe on the other side of the trigger stripe, Y2. Figure 7b. is a scatter plot of the trigger stripe pulse height (Y2) vs. the sum of the pulse heights from it's two neighbors (Y1+Y3).

Figure 7. Distribution of signal among neighboring stripes, ^{57}Co

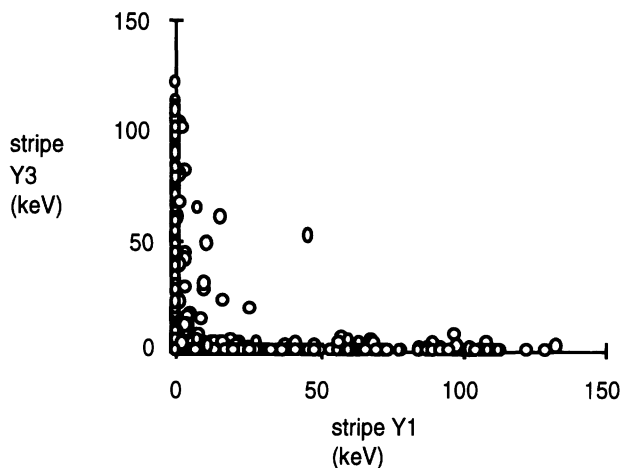

Figure 7a. Event-by-event distribution of ^{57}Co signal among stripes adjacent to the coincidence trigger stripe, Y2.

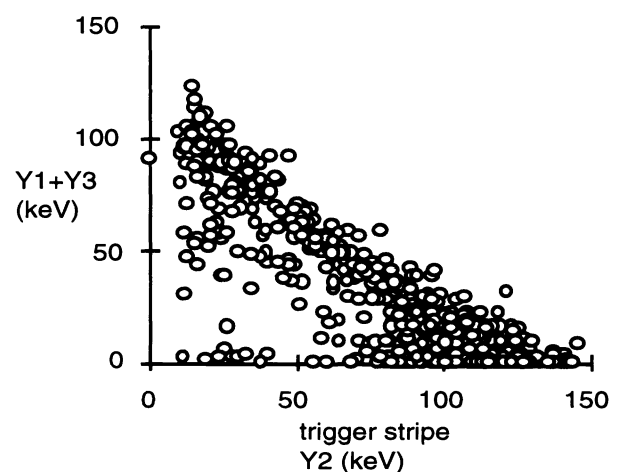

Figure 7b. Event-by-event distribution illustrating signal sharing between the trigger stripe, Y2, and its neighbors

We see in Figure 7a that there is no correlation between the signals from the stripes (Y1, Y3) neighboring the stripe-under-test (Y2). However, we see in Figure 7b that the full charge signal from 122 keV photon interactions triggering the central trigger stripe is shared among the trigger stripe and its nearest neighbors. Figure 7a indicates that for most events this charge is either fully collected on the trigger stripe or shared with one, but not both, of its neighbors. These observations suggest that by 1) using the neighboring stripe pulse heights the strip detector data can be used to locate individual events more precisely than the 0.375 mm stripe pitch and 2) summing the signal contributions from neighboring stripes the strip detector can provide a more efficient total energy measurement of each event. Similar distributions were measured in laboratory tests over the 30 to 662 keV energy range.

4.4 Signal summing

Figures 8a-d show the ^{57}Co and ^{137}Cs response of a single trigger stripe (Y2) in coincidence and the distribution of these same events when the pulse heights of the two adjacent neighbors (Y1 and Y3) are added. This is the simple addition of the pulse height channels (Y1+Y2+Y3) recorded for each event.

Figure 8. Response: single "pixel" and "pixel" plus neighbors

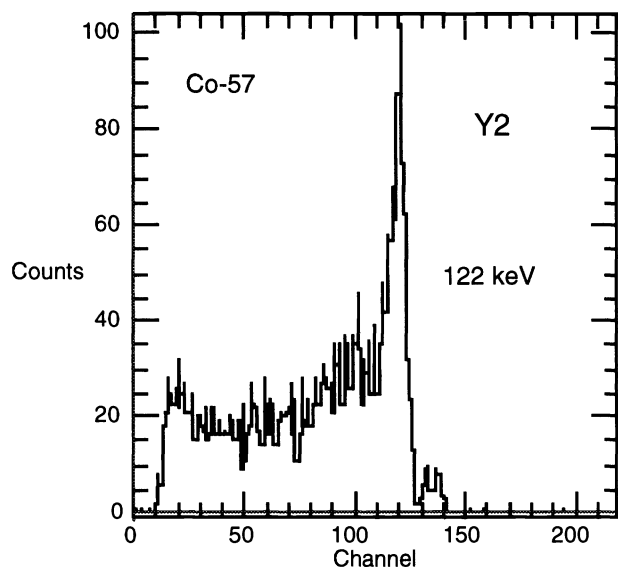

Figure 8a. 3355 ^{57}Co events. Distribution of trigger stripe (Y2) pulse height only. Single "pixel" defined by X2-Y2 coinc.

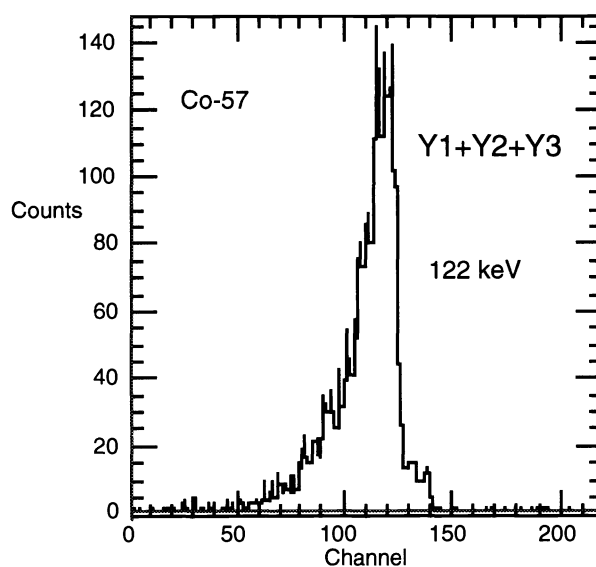

Figure 8b. Same 3355 ^{57}Co events. Distribution of sum of pulse heights, trigger stripe plus adjacent stripes.

Figure 8 (cont.). Response: single "pixel" and "pixel" plus neighbors

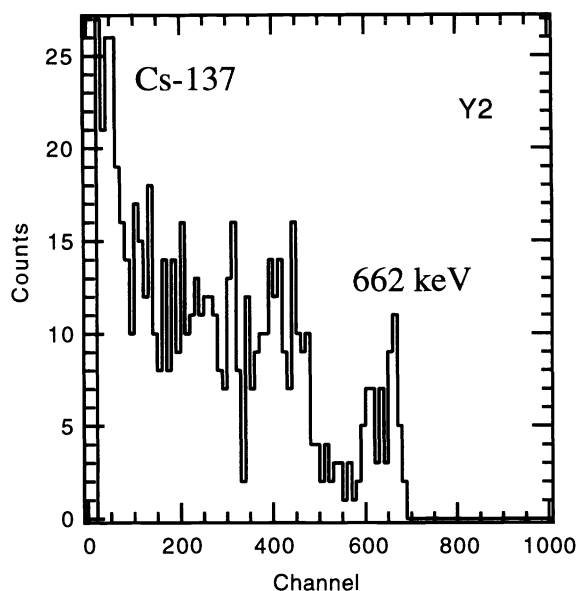

Figure 8c. 672 ¹³⁷Cs events. Distribution of trigger stripe (Y2) pulse height only. 10-channel bins.

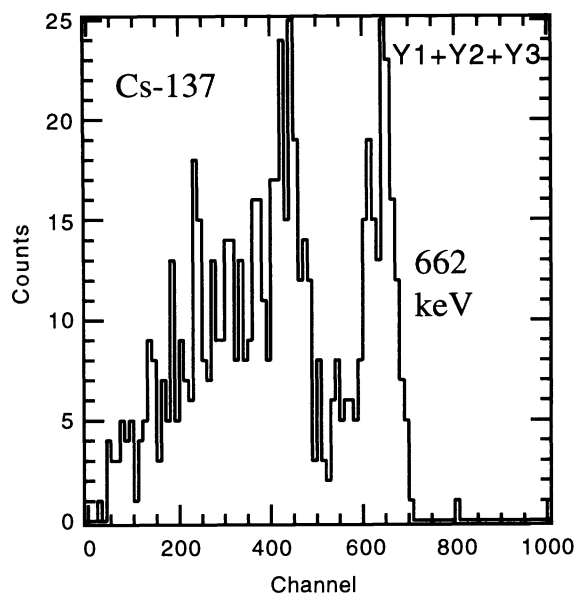

Figure 8d. Same 672 ¹³⁷Cs events. Distribution of sum of pulse heights. 10-channel bins.

In both the ⁵⁷Co and ¹³⁷Cs cases summing the signal significantly enhances the height of the photopeak. The energy resolution is, however, degraded in this test since the separate amplifier gains were not matched and noise from all three amplifier channels was present.

5. APPLICATION TO ASTRONOMICAL INSTRUMENTATION

The necessity for recognizing the time coincidence of X-Y triggers in the strip detector for event location satisfies the timing requirements of astronomical instrumentation. Recognition of charged-particle-induced events is an important background rejection mechanism for space borne instrumentation operating in this energy range. This is normally accomplished through the use of anticoincidence plastic-scintillator charged-particle shields. The in-flight-calibration of the detector elements is important for monitoring changes in response. A technique often employed requires recognition of detections coincident with emissions from tagged radiation sources.

The susceptibility of the detectors to radiation damage and the activation of the detector material in the space environment are important issues. We know of no published studies of the radiation damage to or activation of the new CdZnTe material or detectors made of this material. Further work is necessary.

6. READ-OUT CIRCUIT ISSUES

The strip detector contact geometry requires far fewer signal processing channels than does a pixellated array of the same pitch (128 vs. 4096 in this case). These results further demonstrate that, for each detected event, only the triggered stripes and their neighbors need to be read out. Event-triggered-processing permits precise timing of the detection. This facilitates clear recognition of the required X-Y coincidence as well as the

determination of coincidence and anti-coincidence or relative timing with external events. Ideally each signal-processing channel should contain its own low-noise charge-sensitive preamplifier, discriminator and shaping amplifier and each detector in the image plane array should be controlled and read out by circuitry that occupies the same area or less. The FEENA chip, a 64-channel self-triggering ASIC being developed by Nova R&D, is such a candidate device.¹⁰ Alternatively, consecutive stripes can be grouped and read out via divider networks requiring significantly fewer signal processing channels, one at each end of each group.¹¹ Implementation of such an approach would require less power and occupy less space.

7. FUTURE WORK

Better energy resolution should be possible with fewer interconnections between the stripe and the preamplifier. Imaging demonstrations and the evaluation of the uniformity of response across the detector's active area will require an expansion in the number of active stripes in the test setup. Timing performance and coincidence and anticoincidence operation must also be demonstrated. Radiometry measurements are important for understanding the efficiency of the strip detector operating in the X-Y coincidence mode. A big challenge is to implement such detectors in compact modules that include signal processing electronics with appropriate analog, timing and digital functions.

8. CONCLUSIONS

The performance capabilities of CdZnTe strip detectors are well suited to applications in gamma-ray imaging spectrometers. They have good energy and spatial resolution as demonstrated with conventional laboratory electronics. Good energy response with clear photopeaks in the 30 keV to 662 keV range as well as energy resolution < 10 keV FWHM at 122 keV and spatial resolution < 0.375 mm have been achieved. An $N \times N$ orthogonal stripe detector module requires $2N$ signal processing channels and can achieve performance comparable to pixel detectors requiring N^2 channels.

9. ACKNOWLEDGMENTS

The authors wish to thank UNH students Kipp Larson and Keith Kennedy for careful laboratory measurements and help preparing the figures. We also thank Dr. Brad Barber at the University of Arizona Health Sciences Center for helpful discussions.

10. REFERENCES

1. M. L. Cherry, P. P. Altice, M. B. Bakarat, C. X. Chen, B. K. Dann, A. Drake, S.B. Ellison, C. J. Gagne, J. Gordon, T. G. Guzik, R. Lockwood, K. Johnston, J. Macri, M. L. McConnell, V. Nagarkar, J. M. Ryan and S. Vasile, "A New Balloon-Borne Detector for High Angular Resolution Hard X-Ray Astronomy", Proceedings, 24th International Cosmic Ray Conference, Rome, August 1995.
2. A. Parsons, C. M. Lisse, C. M. Stahle, N. Gehrels, B. J. Teegarden, S. Babu, N. Cao and P. Shu, "Room Temperature CdZnTe and HgI₂ Detectors for Hard X-Ray Astrophysics", Proceedings, IEEE Nuclear Science Symposium, Norfolk, VA, 1994.
3. Skinner, G.K., "Imaging of Cosmic X-Ray Sources Using Coded Mask Techniques." Nucl. Instr. Methods Phys. Res., 221, 33, 1984.
4. F. P. Doty, J. F. Butler, J. Schetzina, K. Bowers, "Properties of CdZnTe crystals grown by a high pressure Bridgman method", Proc. 1991 U. S. Workshop on the Physics and Chemistry of HgCdTe and Other II-VI Compounds, D. E. Seiler (Ed.), Journal of Vacuum Science and Technology B10,1418, 1992.

5. J. F. Butler, F. P. Doty, B. Apotovsky, S. J. Friesenhahn, C. L. Lingren, "Progress in Cd_{1-x}Zn_xTe radiation detectors", *Semiconductors for room temperature radiation detector applications*, R. B. James, T. E. Schlessenger, P. Siffert and L. Franks (Eds.) Proc. Mat. Res. Soc., 302,497, 1993.
6. F. P. Doty, J. F. Butler and P. L. Hink, "X-Ray and Gamma Ray Imaging with Monolithic CdZnTe Detector Arrays", Proceedings, SPIE-OE/Aerospace Sensing, 1945, 145, Orlando, FL, 1993.
7. R. Polichar, R. Schirato, J. Reed, "Development of CdZnTe energy selective arrays for industrial and medical radiation imaging" Nuclear Instruments and Methods in Physics Research, A 353, 349-355, 1994.
8. F. P. Doty, H. B. Barber, F. L. Augustine, J. F. Butler, B. A. Apotovsky, E. T. Young, W. Hamilton, "Pixellated CdZnTe detector arrays", Nuclear Instruments and Methods in Physics Research, A 353, 356-360, 1994.
9. H. H. Barrett, J. D. Eskin and H. B. Barber, "Charge transport in arrays of semiconductor gamma-ray detectors", accepted to Physical Review Letters, in press.
10. T. O. Tumer et al., "Front End Electronics for Nuclear Applications (FEENA Chip)", 9th International Workshop on Room Temperature Semiconductor X- and Gamma Ray Detectors Associated Electronics and Applications, Grenoble, September 1995.
11. R. A. Kroeger, S. E. Inderhees, W. N. Johnson, R.L. Kinzer, J. D. Kurfess, N. Gehrels, "Charge division readout of a two-dimensional germanium strip detector", Nuclear Instruments and Methods in Physics Research, A 348, 507-509, 1994